



ROJO FOX

Portable Projector

K2N



※ User Manual ※

Attention

Please read this manual carefully before use and keep it for future reference.

- 1.The projector is non dustproof or waterproof.
- 2.In order to reduce the risk of fire and electric shock, do not expose the projector to rain and fog.
- 3.Please use the original power adapter. The projector should work under specified rated power supply.
- 4.When projector is working, please do not look directly into the lens, the strong light will flash your eyes and cause slight pain. Children should use the projector under the supervision of adults.
- 5.Do not cover the vents of projector. Heating will reduce the life of projector and cause danger.
- 6.Regularly clean projector vents, or dust may cause cooling malfunction.
- 7.Do not use the projector in greasy, damp, dusty or smoky environment. Oil or chemicals will cause malfunction.
- 8.Please handle with care during daily use.
- 9.If the projector is not used for a long time, please cut off the power.
- 10.Non professionals are prohibited from dismantling, testing, and repairing the projector of this equipment on their own

Structure Description

The following equipment pictures and functional descriptions are for reference only, and the actual product shall prevail. If any Modifications are subject to change without prior notice, and our company reserves the right to final interpretation.

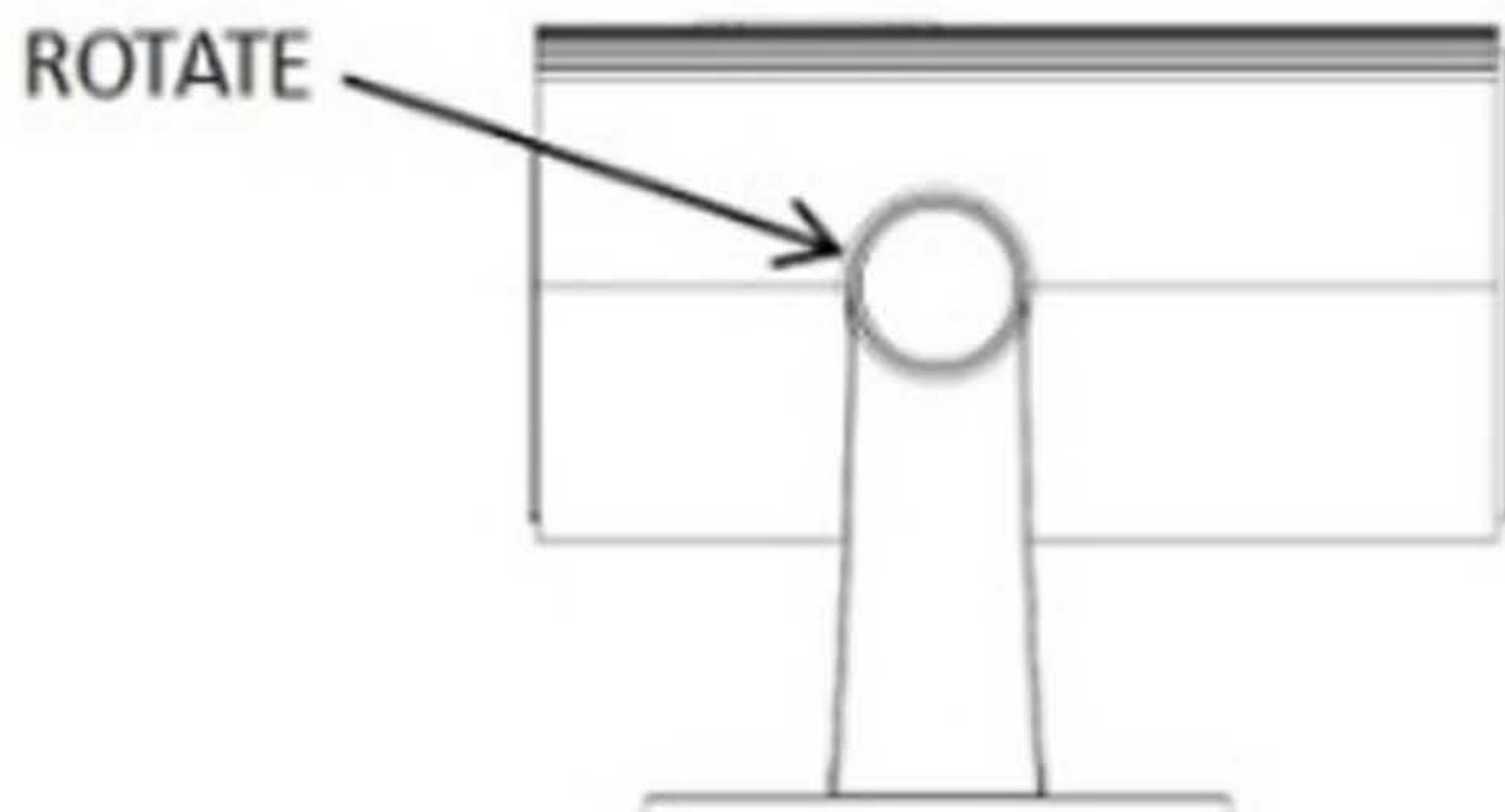
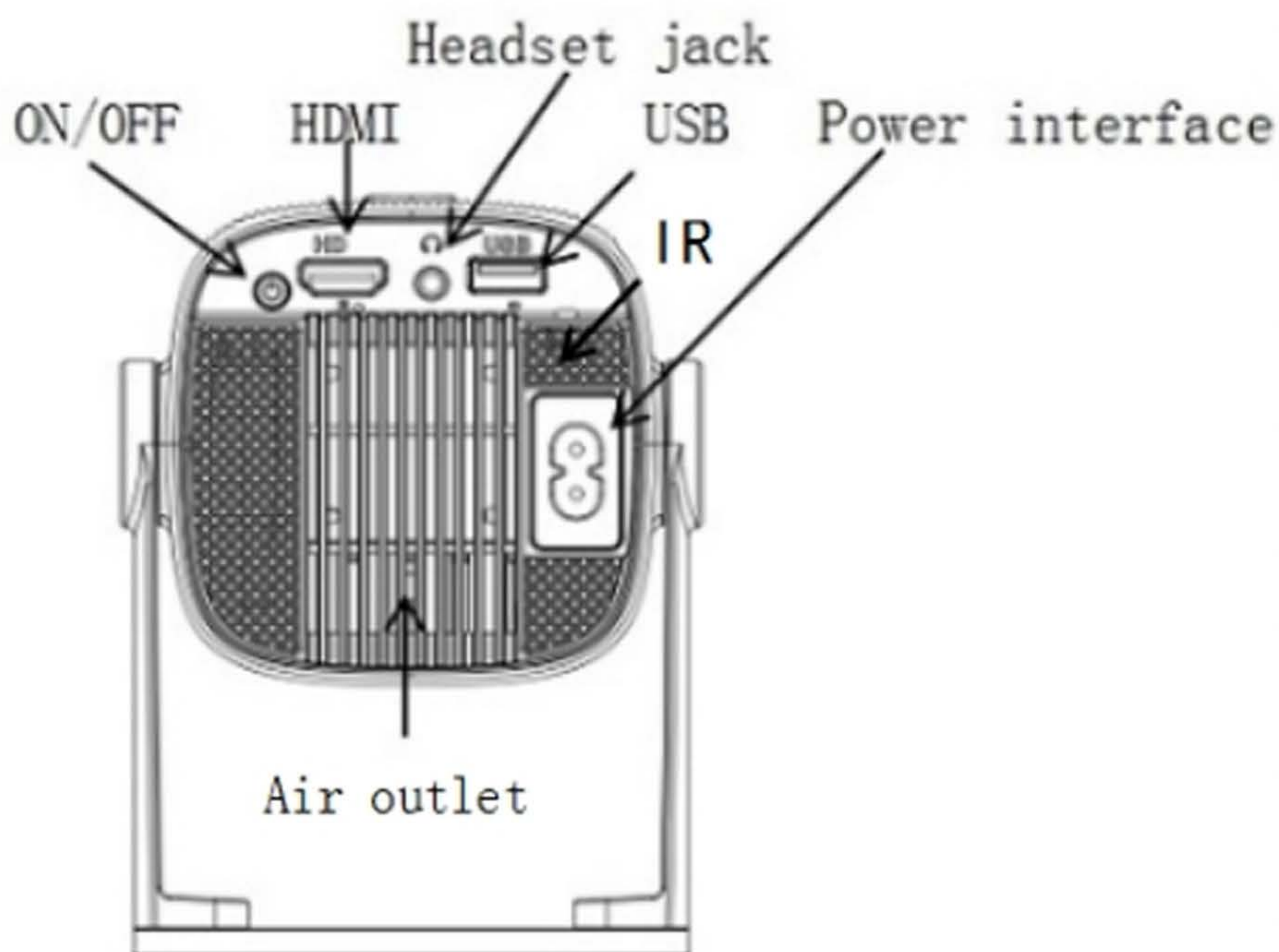

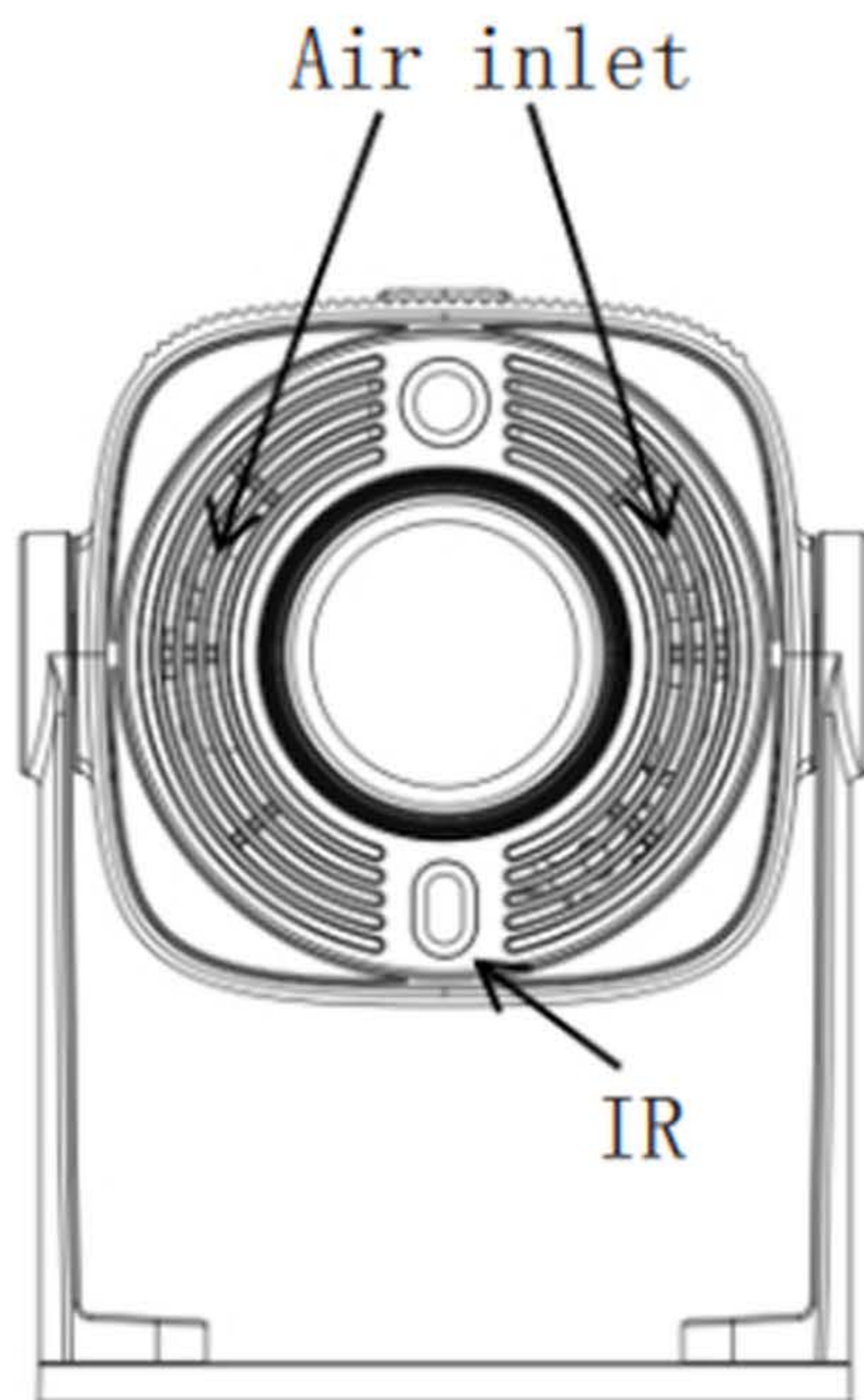

Remote Control Function Description



Power		Home
Volume-	Mute	Volume+
	UP	
Left	OK	Right
	Down	
Menu	Mouse	Back
Focus+		Focus-

Power ON/OFF

Power On

Long press Power button on projector for 3 seconds.

Power Off

When the projector is power-on, press and hold the power button on the projector or the remote control for 3s to power off.

ON/OFF

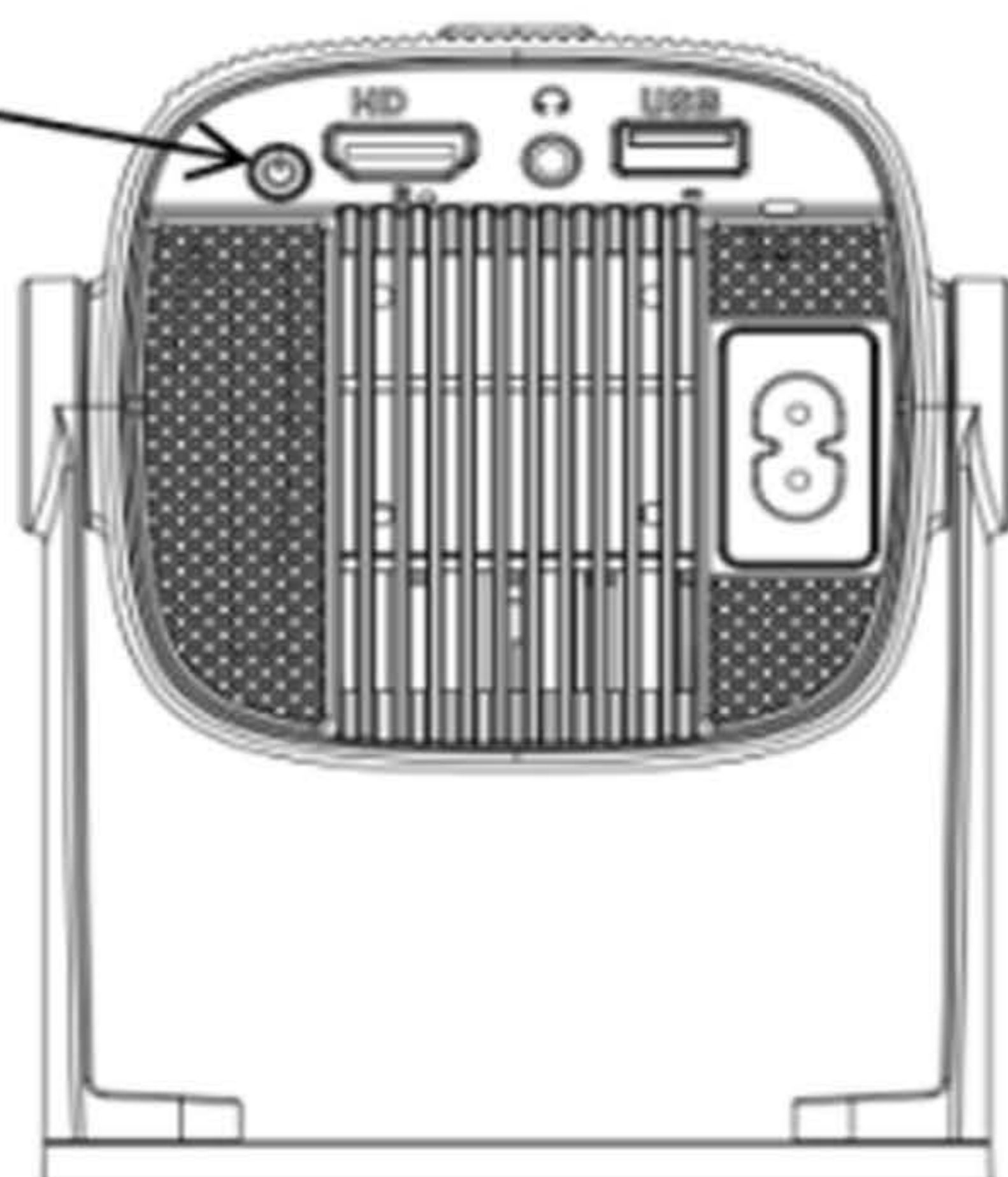

Focus Adjustment

When the projector is turned on, use the focus button on the remote control to adjust the lens position to a clear state on the projector screen.

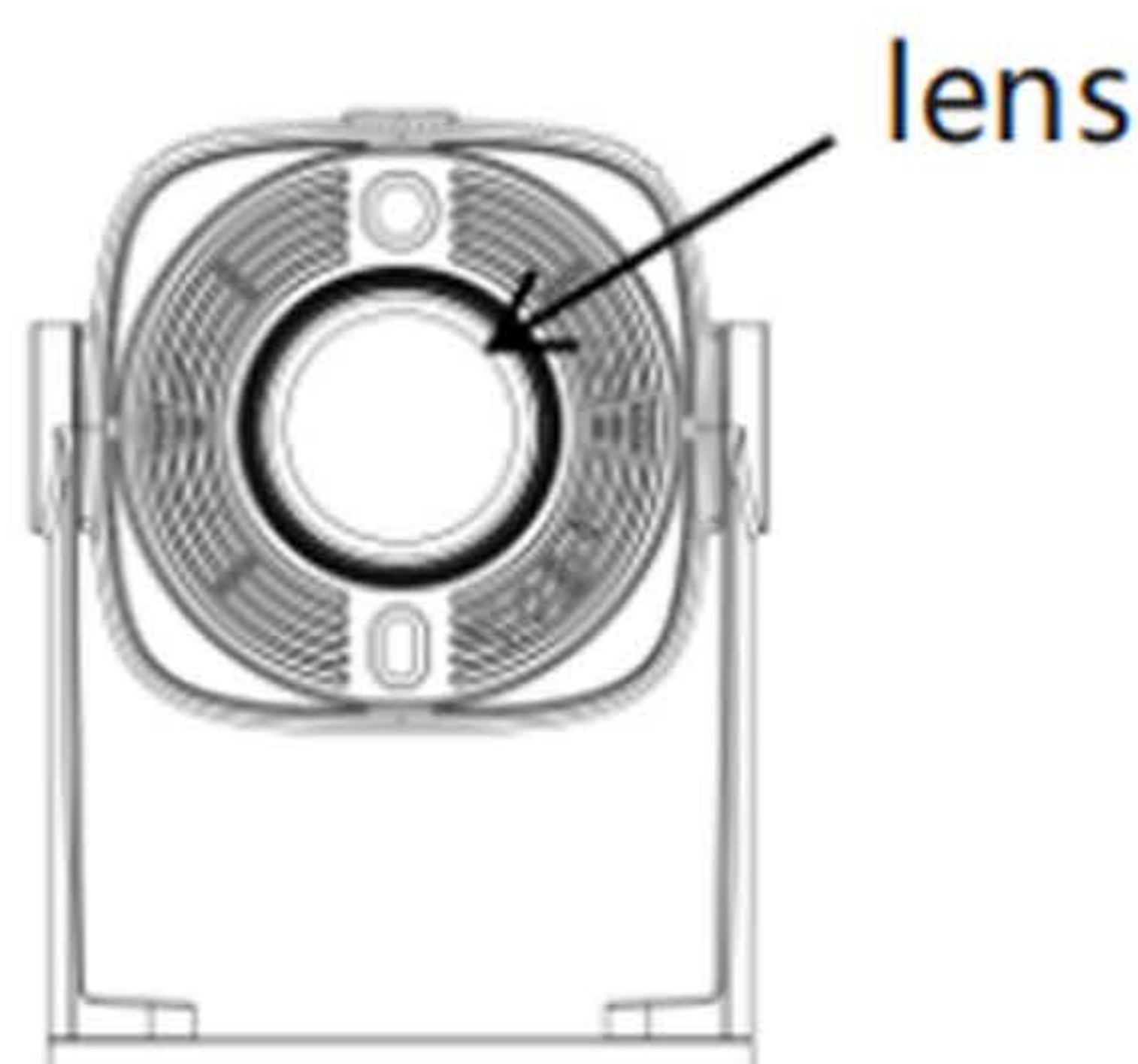

Launcher UI

Note: Enter the setting of two displays, please refer to the actual display

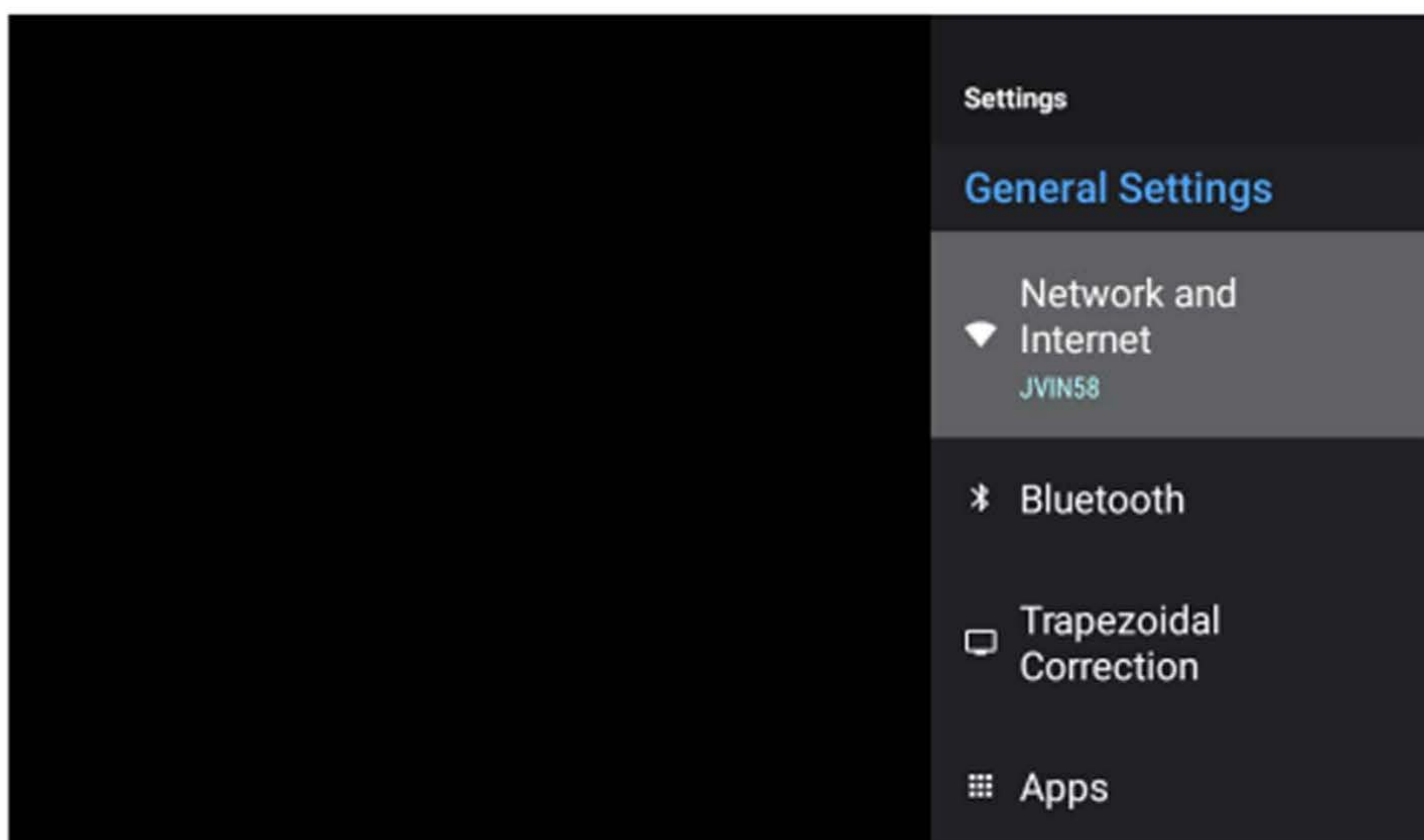
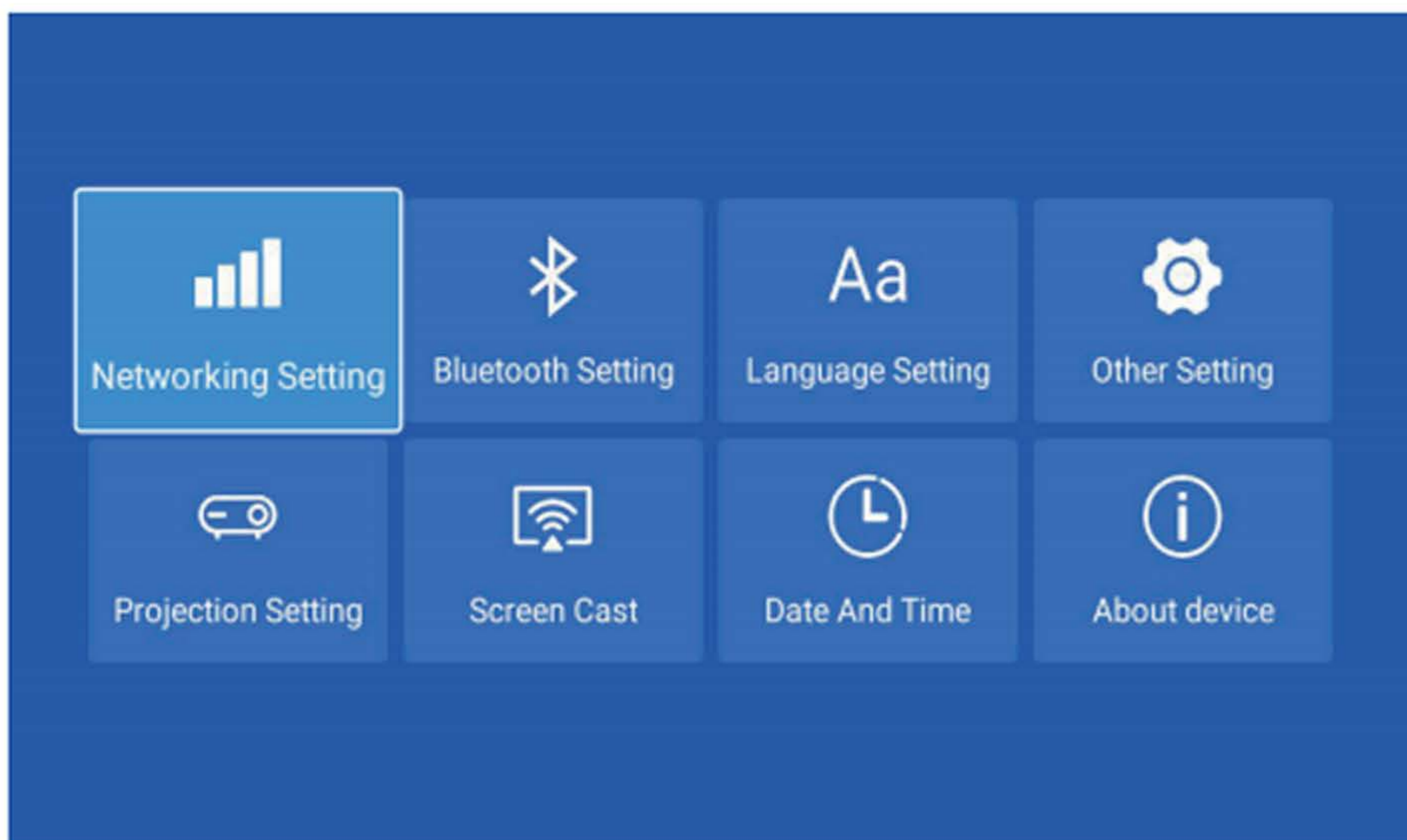

OSD Language

Setting - System Settings - OSD Lang > To choose your language.

Note: The language display interface may be one of the following, please refer to the actual display

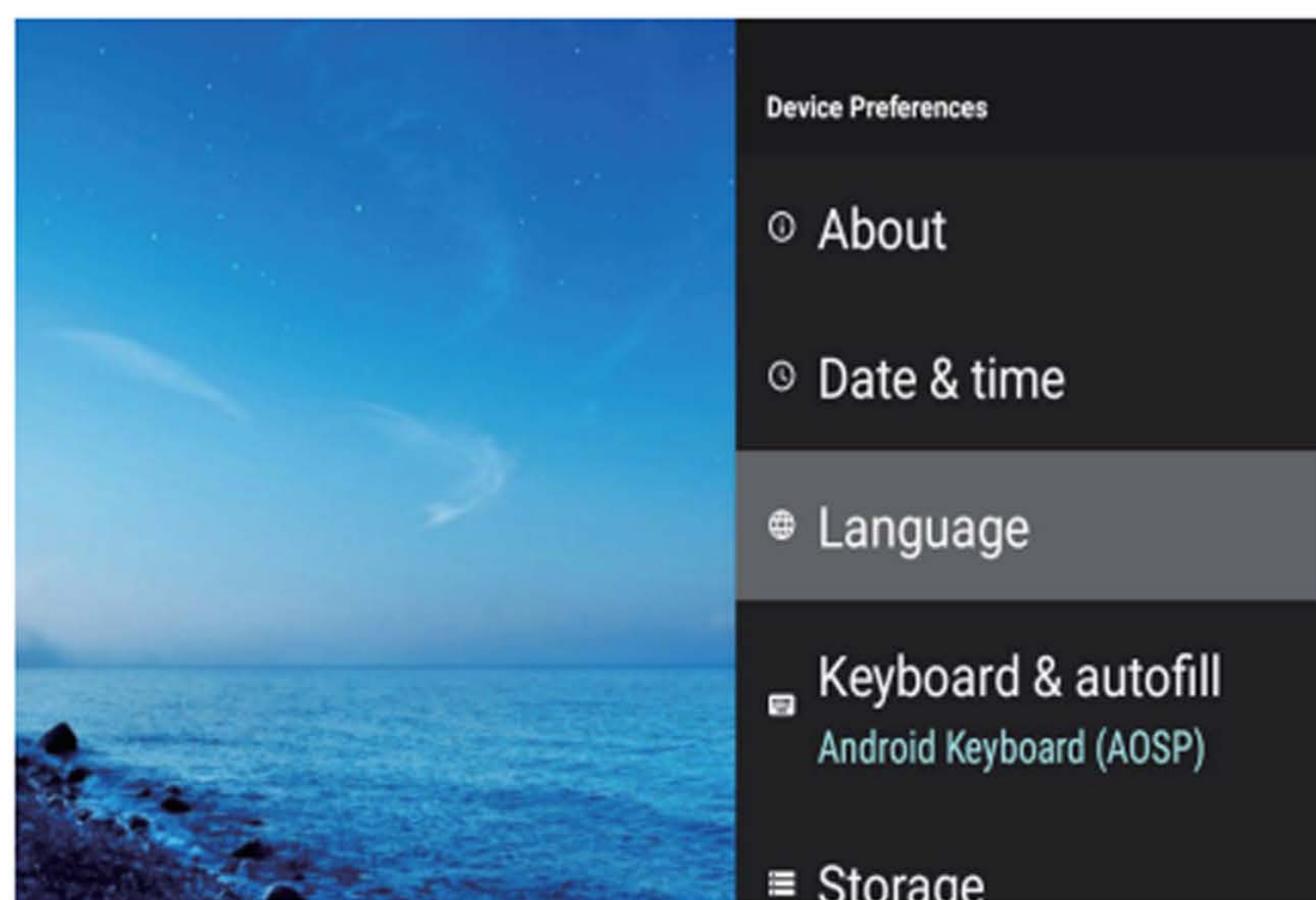

Home Background

Setting - System Settings - Home Background > Choose the Home Background you want < Blue, Dark blue, White, Grey >.

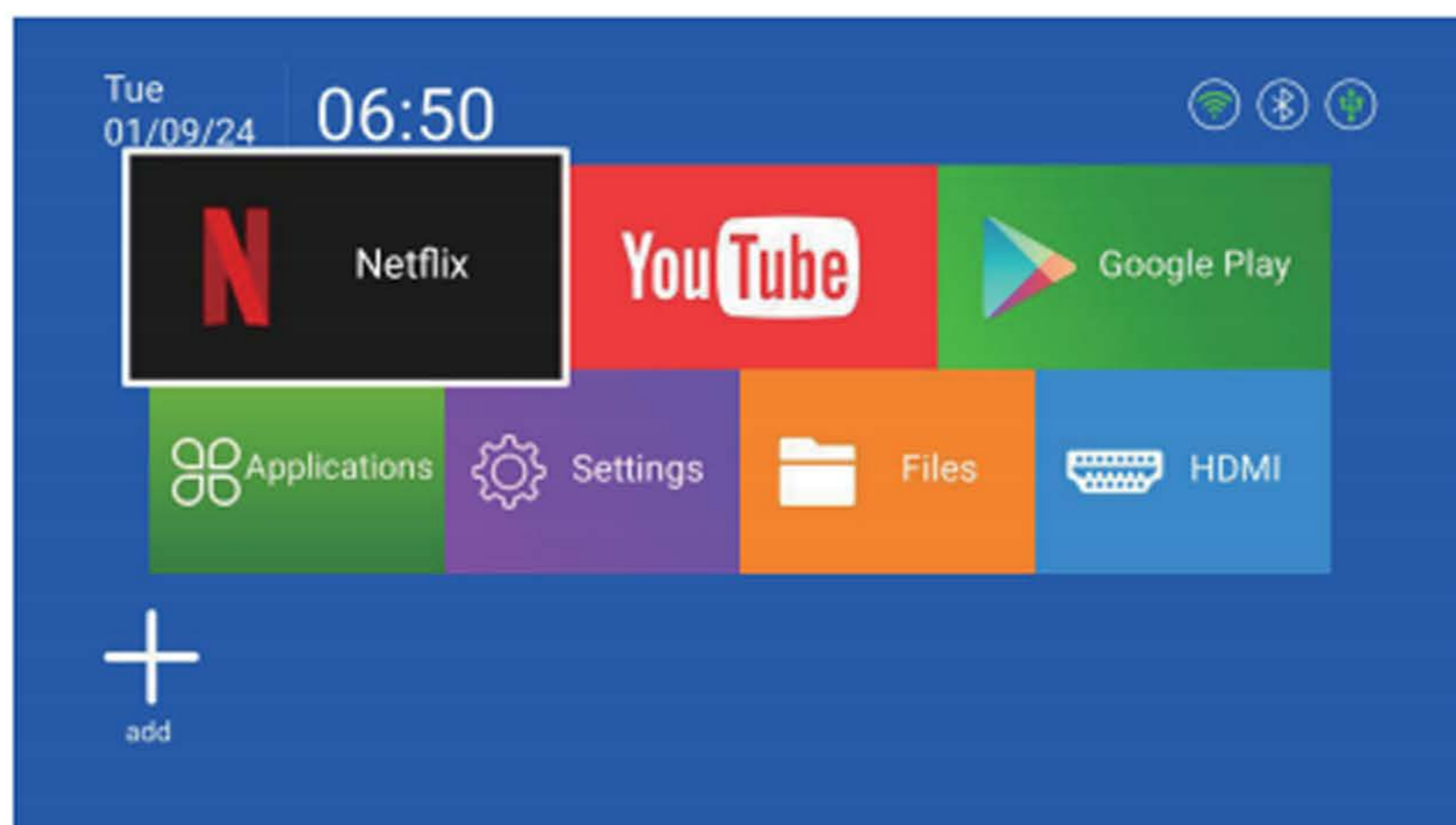

Projector Mode

Setting - System Settings - Flip > To select different mode according to your application scenario. Four modes are available < Front Table, Front Ceiling, Back Table, Back Ceiling >.

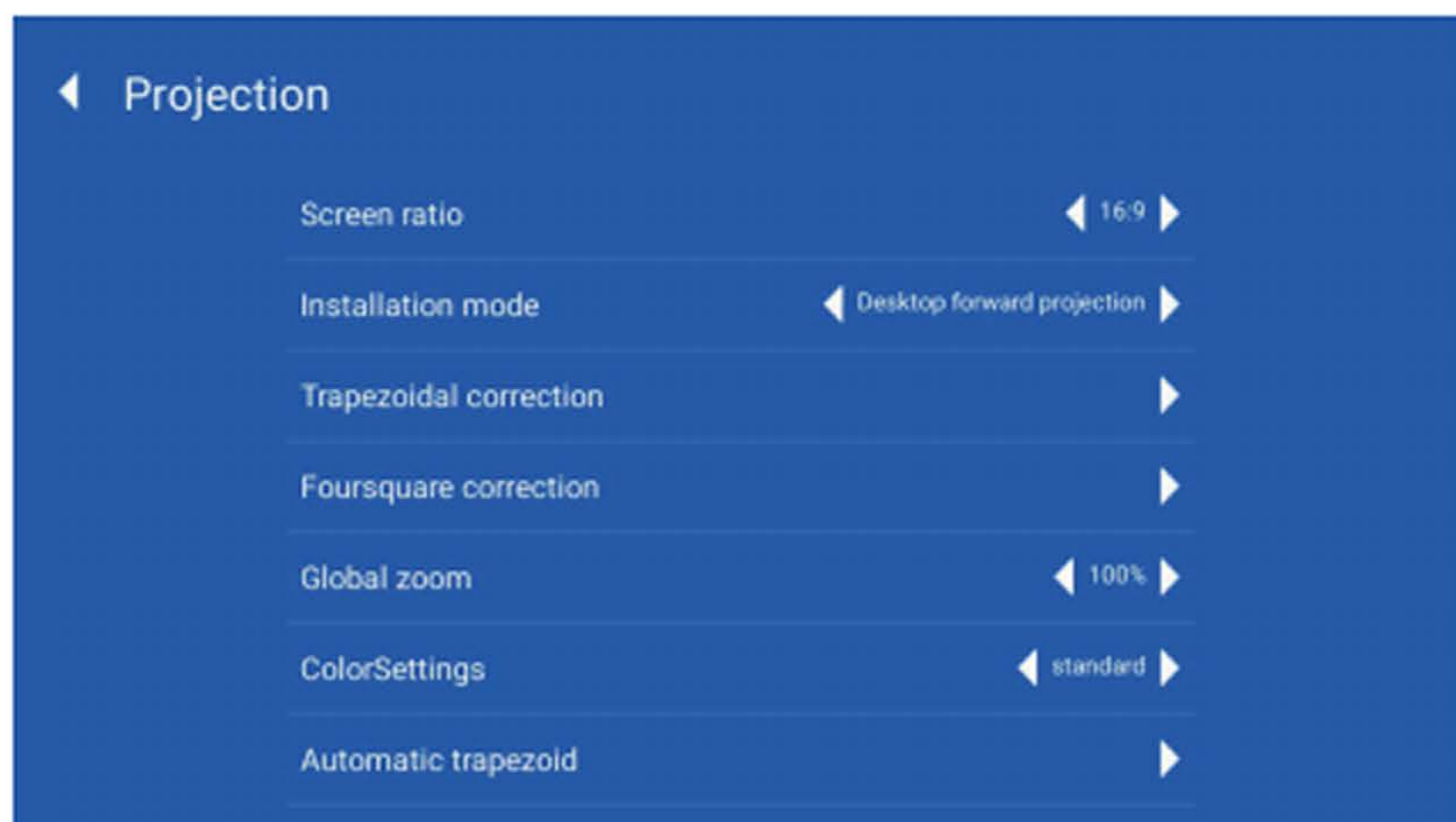

Media Player

Insert the U disk and click the USB icon on the homepage to read the local video & music & photo & Book.

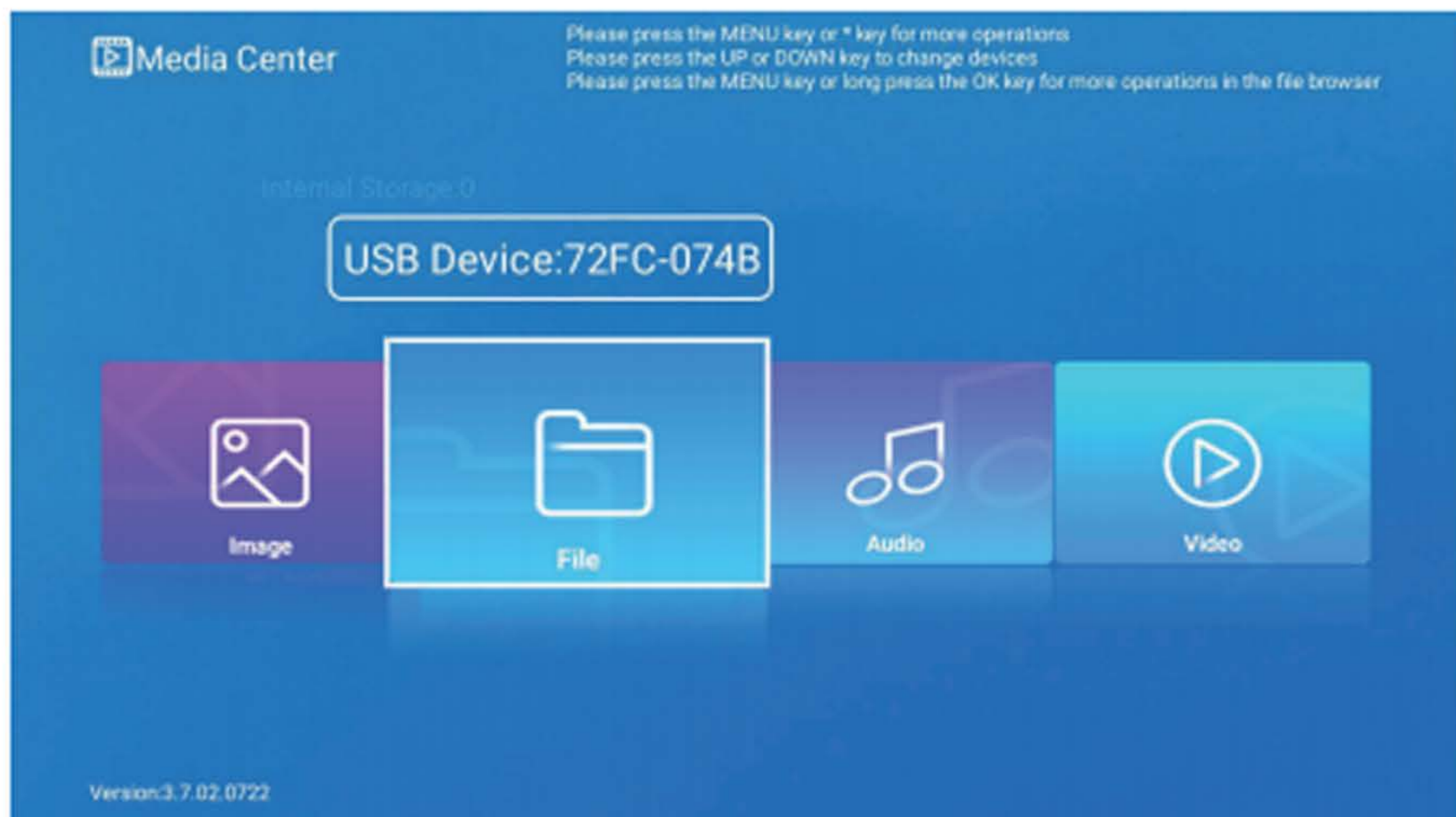

HDMI Signal

Connect projector and external sourcing device by HDMI cable. Enter HDMI on the homepage, the signal from the sourcing device will be transmitted to projector and cast out.

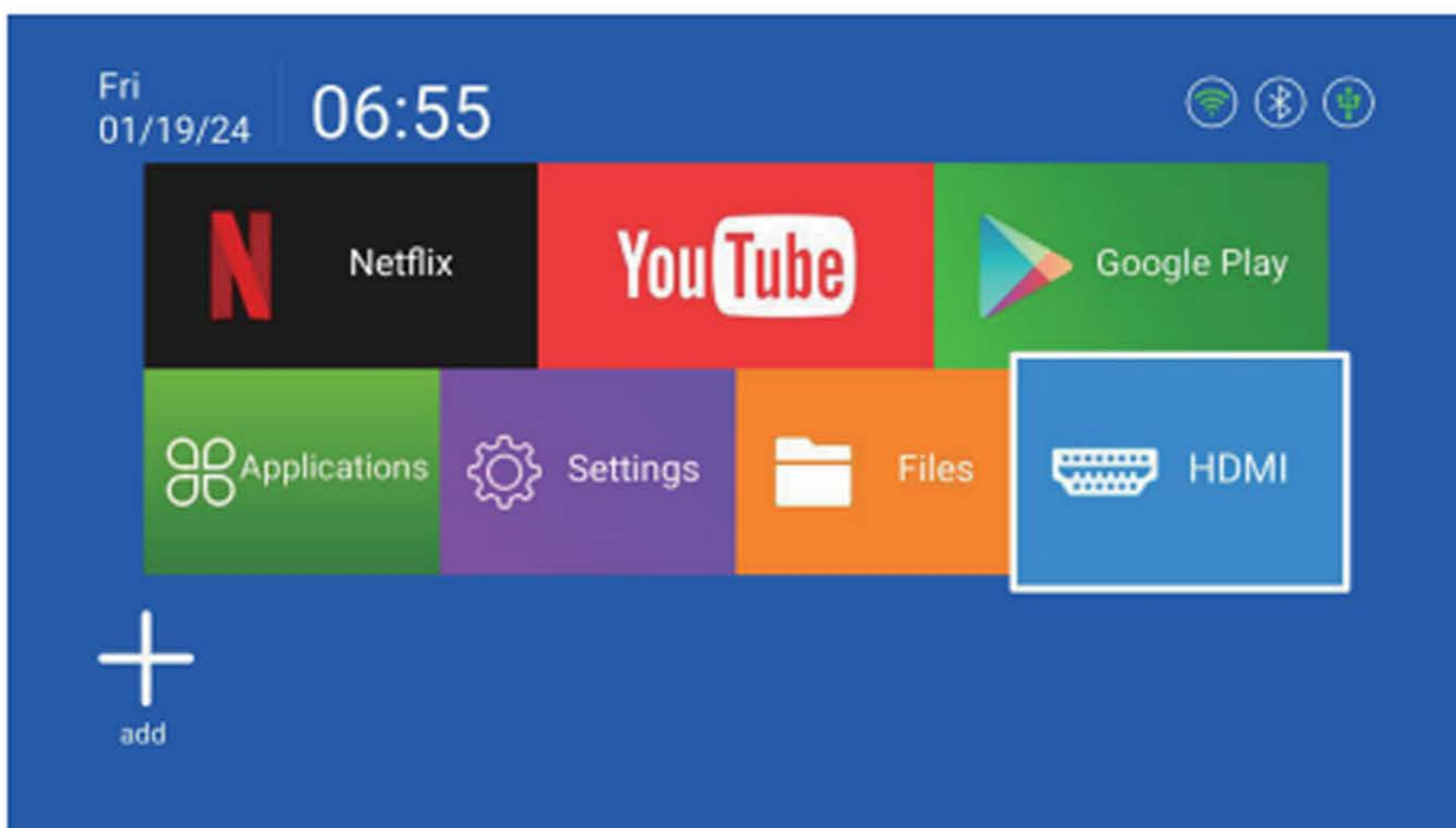

On-screen image

Ios system

1. Connect the projection device and the mobile phone to the same network.
2. Slide down the phone to open the control center and click the screen mirror button (slide up the. iPhone6/7/8 series phone to open the control center).
3. Select the name of the device to be on the same screen and start on the same screen.

Note: Please refer to the actual display of the same screen interface, and follow the prompts

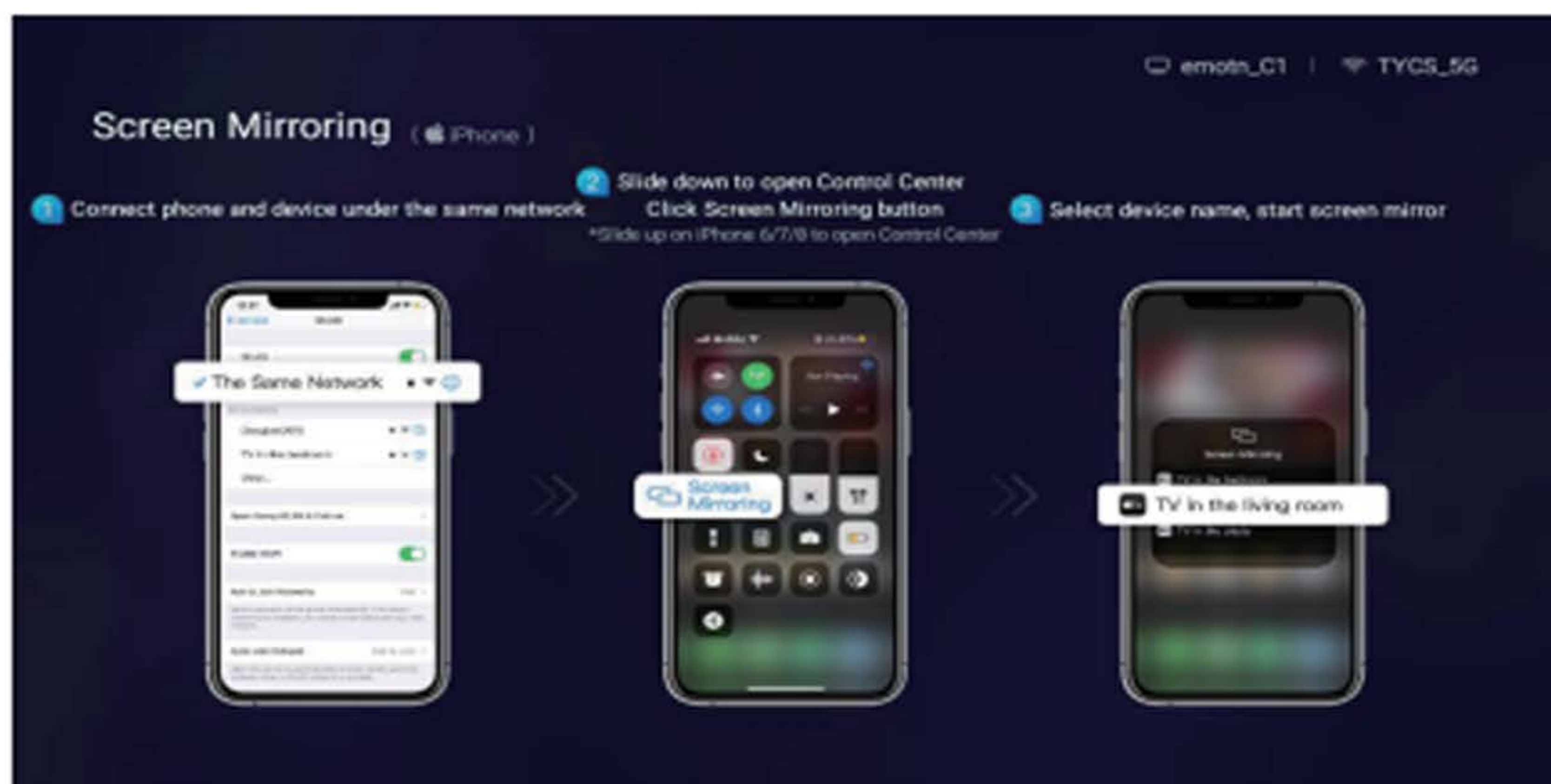
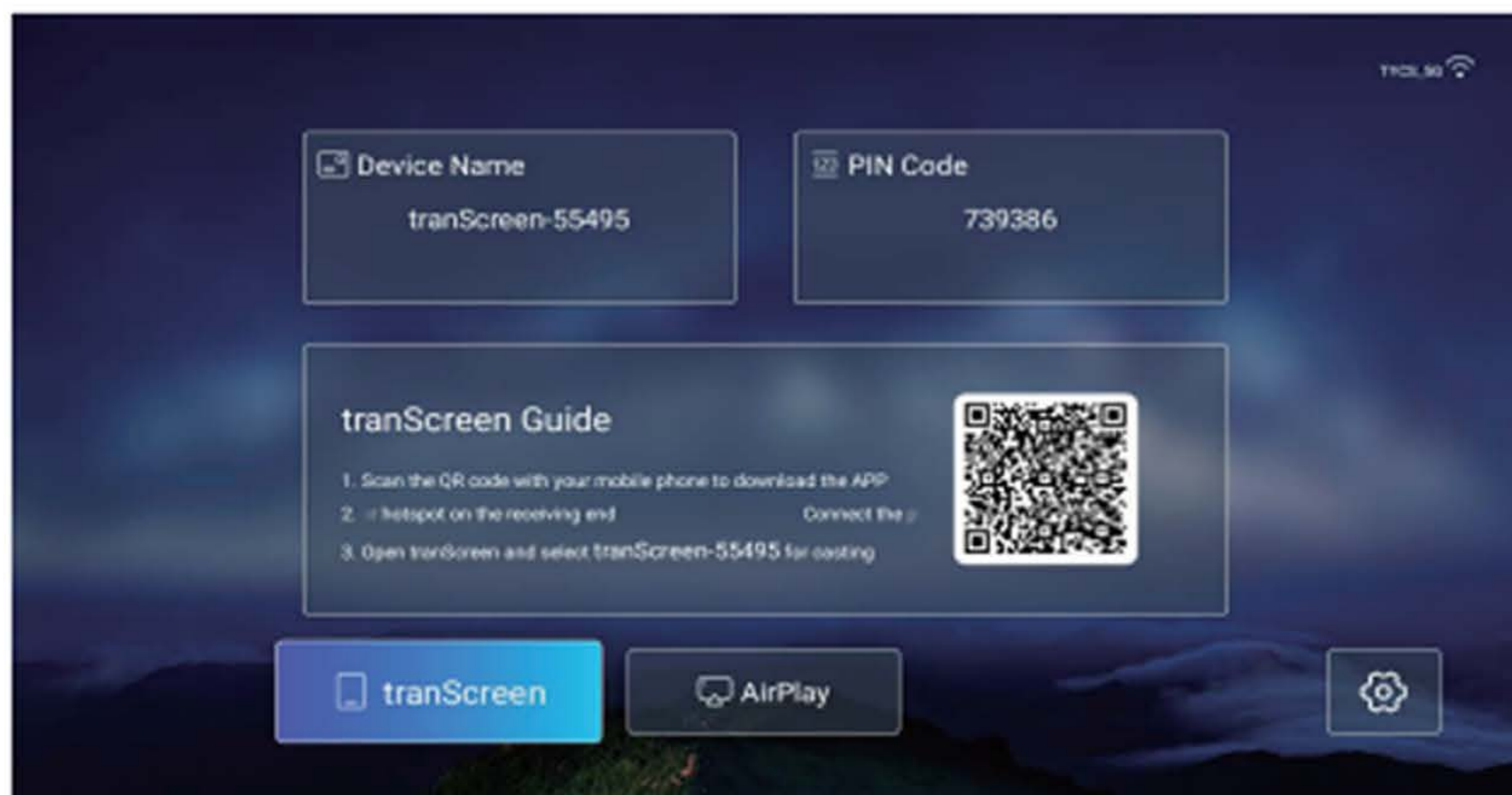

Android @ISO screen projection

1. Connect the projection device and the mobile phone to the same network.
2. Open the mobile APP playback interface and click the words "Show TV".
3. Select the device name to complete the screen projection.

Note: There are two projection interfaces, please refer to the actual display, and follow the prompts

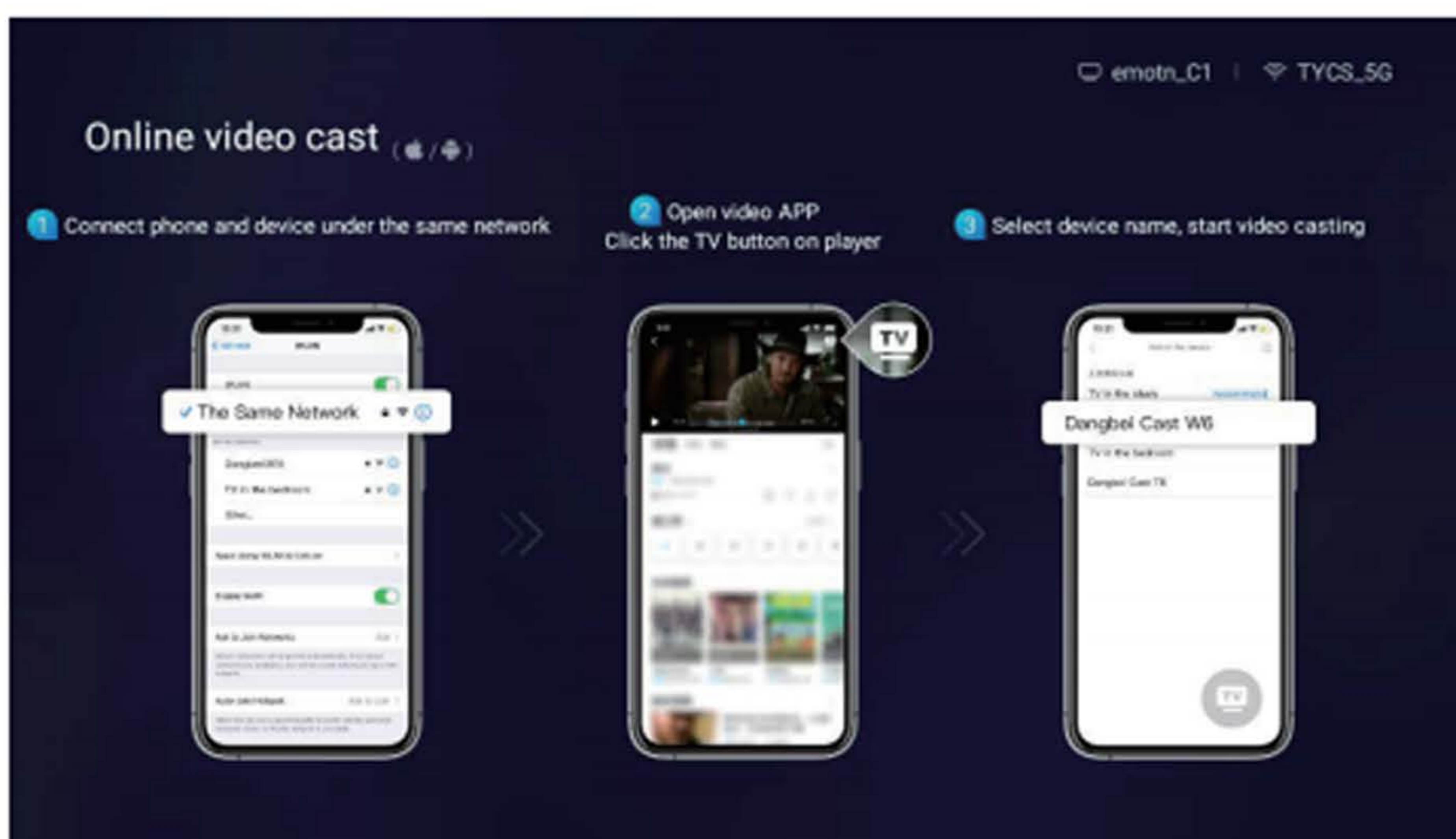
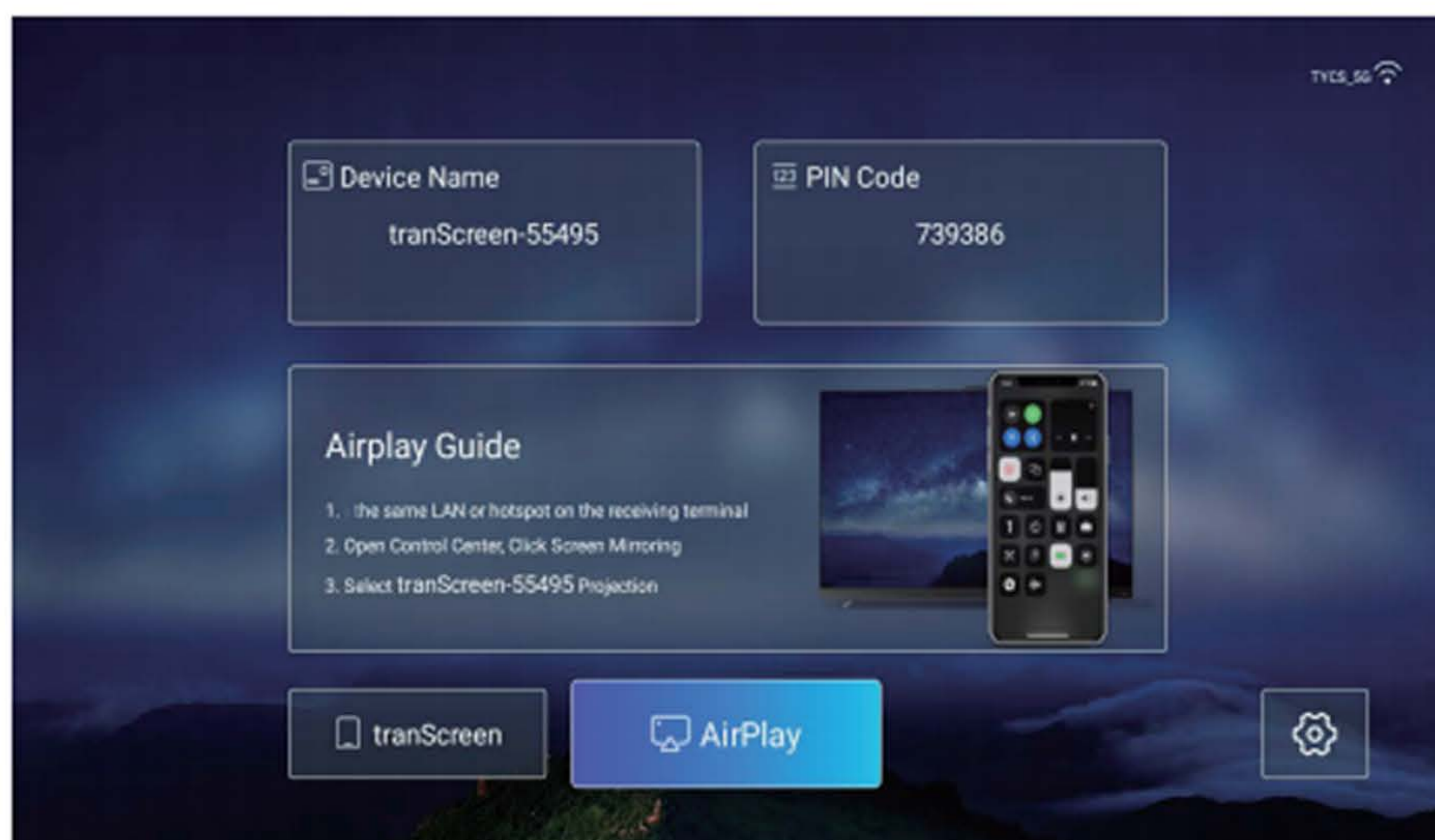

【Safety instructions】

- Please pay attention to important information related to the operation and maintenance of the projector. You should read this information carefully to avoid problems. Following safety instructions will increase the life of projector.
- Please consult the qualified personnel for installation and repair services, and do not use damaged wires, accessories and other peripherals.
- Projector should be kept away from flammable, explosive, strong electromagnetic interference (large radar stations, power stations, substations) ,etc. Strong ambient light (avoid direct sunlight), etc.
- Do not cover projector vents.
- Please use the original power adapter.
- Keep adequate ventilation and make sure vents are not covered to avoid projector overheating.
- When projector is working, please do not look directly into the lens, the strong light will flash your eyes and cause slight pain.
- Do not bend or drag the power cord.
- Do not put power cord under projector or any heavy objects.
- Do not cover other soft materials on power cord.
- Do not heat the power cord.
- Avoid touching power adaptor with wet hands.

【Disclaimer】

This manual is general instructions, The pictures and functions in this manual should subject to the actual product. Our company is devoting to improve product performance, we reserve the right to modify product functions and interface described in this manual without notice.

Please keep your device properly. We are not responsible for any loss caused by wrong operation of software/hardware or repairing or any other reasons. We are not responsible for any loss of any third party claims.

This manual has been carefully checked by professional engineer, please understand for any inevitable omissions.



Attention:

Please do not look directly into the lens when projecting to prevent the strong light doing harm to your eyes. Kids should use the projector under the supervision of adults.